



Catalogue

2019

*Always copied . . .
. . . never bettered*

portek.co.uk

Contact us

Portek Ltd.
 Bryn Hall, Knolton Bryn
 Overton-on-Dee
 Wrexham, LL13 0LF
 Tel: 01234 889 454
 Fax: 01234 889 464

Sales enquiries

Email: sales@portek.co.uk

General enquiries

Email: info@portek.co.uk

Remittance and accounts enquiries

Email: accounts@portek.co.uk

**Portek Limited
 only supply
 the trade**

Visit our website to
 find your nearest
 Portek dealer

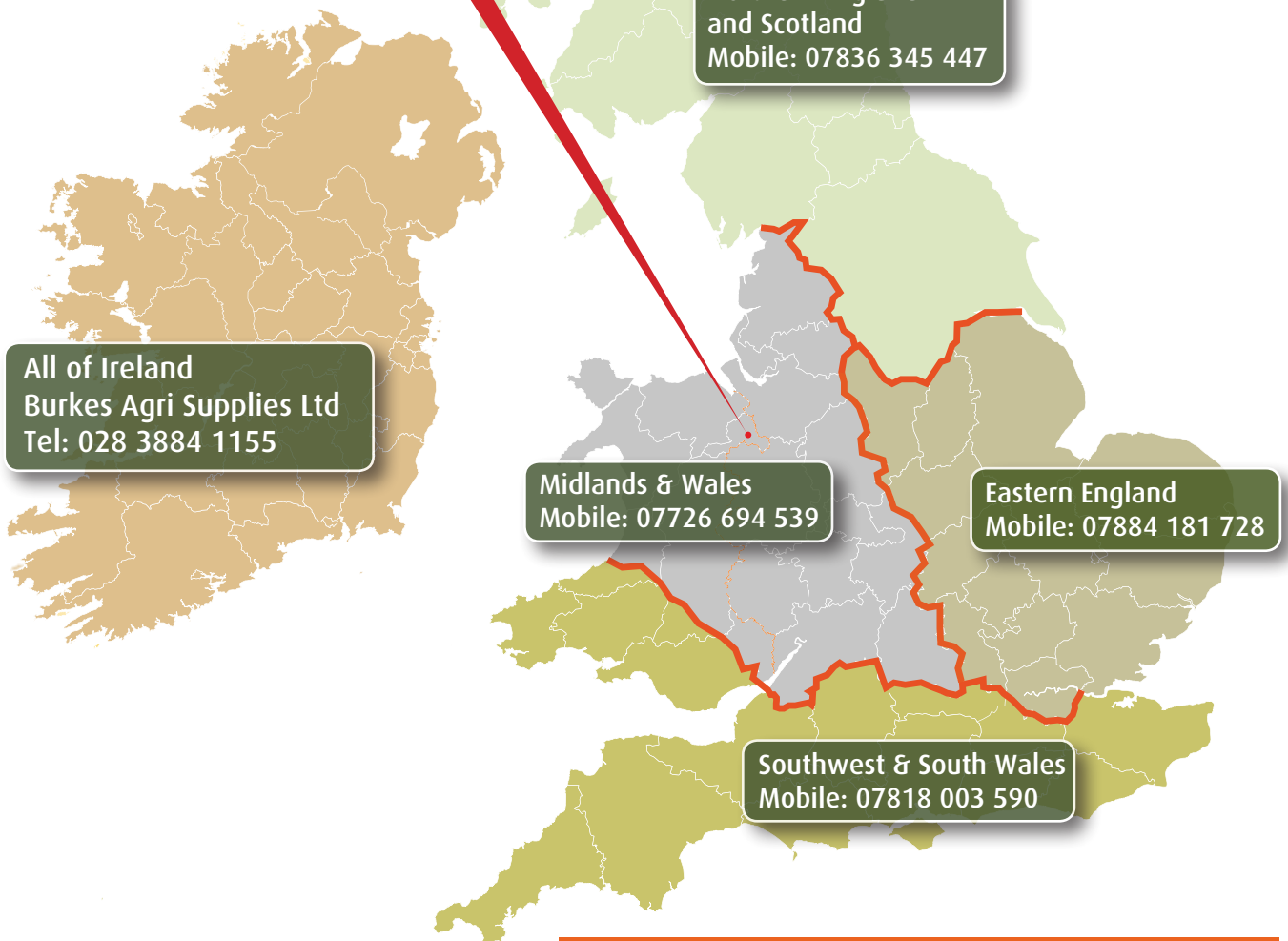

ALWAYS WEAR SAFETY AND PROTECTION
 EQUIPMENT TO HSE/EN SPECIFICATIONS - SEE PAGE 57



www.portek.co.uk

Birdscaring

Portek has the widest range of birdscaring products available in Europe; from well-known simple banger ropes and rockets, to sophisticated laser technology and high-tech electronic gas guns.

New to the range is the innovative Scatterbird Mk4 with amazing advanced control system to adjust timing, frequency and even the loudness of the bang.

The new Hunter wind guided life-size bird scarer that stands guard over your crops and can be used to great effect with our range of banger ropes.

Also introduced is the traditional but effective Hanging Crow scarer; using a tried and tested method to deter the birds.

| | |
|------------------------------|----|
| Scatterbird MK4 - NEW | 4 |
| Skybird Rockets | 8 |
| Banger Ropes | 10 |
| Hanging Crow - NEW | 12 |
| Hawkeyes | 13 |
| Sentinel | 14 |
| Cropgard | 16 |
| The Hunter | 18 |
| Terror Kite & Terror Hawk | 20 |
| BirdYell | 22 |
| LaserStrike | 24 |

Foot Trimming

The well proven Cow Clog treatment for lameness.

| | |
|-------------------|----|
| Original Cow Clog | 26 |
|-------------------|----|

Landscaping & Workshop Products

Introducing our new FlexiSharp rechargeable autoclamp chainsaw sharpener that enables you to work anywhere.

Introducing the advanced Charger 8.5 ton kinetic logsplitter. The **ONLY** kinetic logsplitter in the UK to meet the latest CE safety and guarding regulations.

New to the range is the FlexiVice, a truly versatile and robust vice perfect for any workshop.

This season also brings the powered fence Post Driver. Taking the backache and strain out of fencing.

And finally we have an improved tripod garden sprinkler with more control and an oscillating sprinkler that is built to last.

| | |
|--|----|
| Logmaster Saw Horse | 28 |
| Post Driver - NEW | 30 |
| Charger 8.5 Ton Log Splitter - NEW | 32 |
| Log Splitting Axes | 36 |
| ChainSharp 12v Sharpener | 37 |
| FlexiSharp Sharpener - NEW | 38 |
| Maxi ChainMaster Autoclamp | 40 |
| Ultra ChainMaster MK3 | 42 |
| FlexiVice - NEW | 44 |
| Powerstrim Strimmer Heads | 46 |
| RufCut Brushcutter | 48 |
| Tripod Garden Sprinkler - IMPROVED DESIGN | 52 |
| Oscillating Garden Sprinkler - NEW | 53 |

Spraying & Chemical Handling

A range of useful products to combat the ever increasing legislation regarding agricultural chemicals; helping farmers to protect the environment and their livelihood.

| | |
|-------------------------------|----|
| Boutafoam Field Marking Fluid | 54 |
| Chemdrip Drainage Tray | 55 |
| Chemdrip Spill Bund | 56 |

All dimensions quoted are approximate. Our policy is one of continuous improvement. Whilst every effort has been made to achieve the degree of reliability and accuracy appropriate to products of this kind, the right is reserved to make changes at any time, without notice, to prices, materials, specifications and models. In no circumstance will Portek Ltd, its servants or its agents, accept any liability for statements made or any error or inaccuracy relating to any of its products, or for any resulting damage, loss, expenses or claims whatsoever.

© 2019 Portek Ltd. Issue 0119-4k

Scatterbird MK4



DESIGNED AND
BUILT IN BRITAIN

SCATTERBIRD
GAS POWERED BIRD SCARER **MARK 4**

• The best just got even better



**BLUETOOTH
SMARTPHONE
CONNECTION**

Free downloadable app
Search for "Scatterbird"

**Does NOT require
internet or phone
signal to work**

Part No.
030

**No Smartphone?
No Problem**



**Portek optional remote
controller Part No. 033/34**

The Next Generation of Gas Gun



Up to 20 metres

Program your Scatterbird from the comfort of your home or office - then go to field to activate up to 20 metres



ALL NEW DESIGN!

Scatterbird MK4 - Features

This gas gun has been designed and developed to incorporate ALL the features requested by farmers over the past 30 years



Unique FARM PIN number deters theft
Cannot be used by others

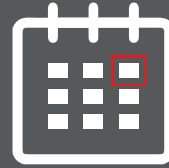

Specific day to day programming of all features tailored to your requirements



Adjust the loudness of the bang for built-up areas from 1 - 5



Select/programme individual days gun on or off



Choose start and finish times each day. App automatically displays sunrise and sunset each day



Manage up to 300 Scatterbirds with different programmes from one phone

The Scatterbird app is available for iOS and Android smart devices and can be downloaded free from the App Store and Google Play Store.



The Next Generation of Gas Gun



Simple snap fit legs included

OPERATION

To operate the Scatterbird MK4 you will need a 12 volt battery and a cylinder of propane gas (any size of propane cylinder is suitable for use).

Use of an optional internal 12 volt battery (not included) is recommended to keep the wiring away from vermin and prevent flood damage to the battery and wiring.

- Free downloadable app uses simple Bluetooth control
- Adjustable volume
- Control multiple Scatterbirds from one remote control
- Personal farm pin number for security
- Ergonomic carry design

State of the art compact electronics fully sealed against the elements

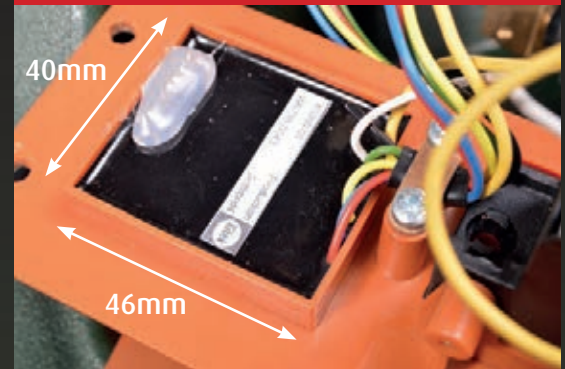

Long life stainless steel inner barrel



Optional internal battery - secure behind easily removable side panel



PART NUMBERS

| | |
|------------------|--------|
| Scatterbird Unit | 030 |
| Remote Control | 033/34 |
| Internal Battery | 034 |
| Battery Charger | 035 |

SkyBird Rockets

SKYBIRD

the ultimate surprise attack



NEVER USE A
LAUNCH TUBE
LESS THAN
15mm
DIAMETER



Minimum 1metre

SkyBird rockets are the **ULTIMATE DETERRENT** to clear away persistent and stubborn birds for long periods

Part No.
052

CE
NB 1395



Danger

Explosive; fire, blast or projection hazard

Agricultural Birdscaring Rockets

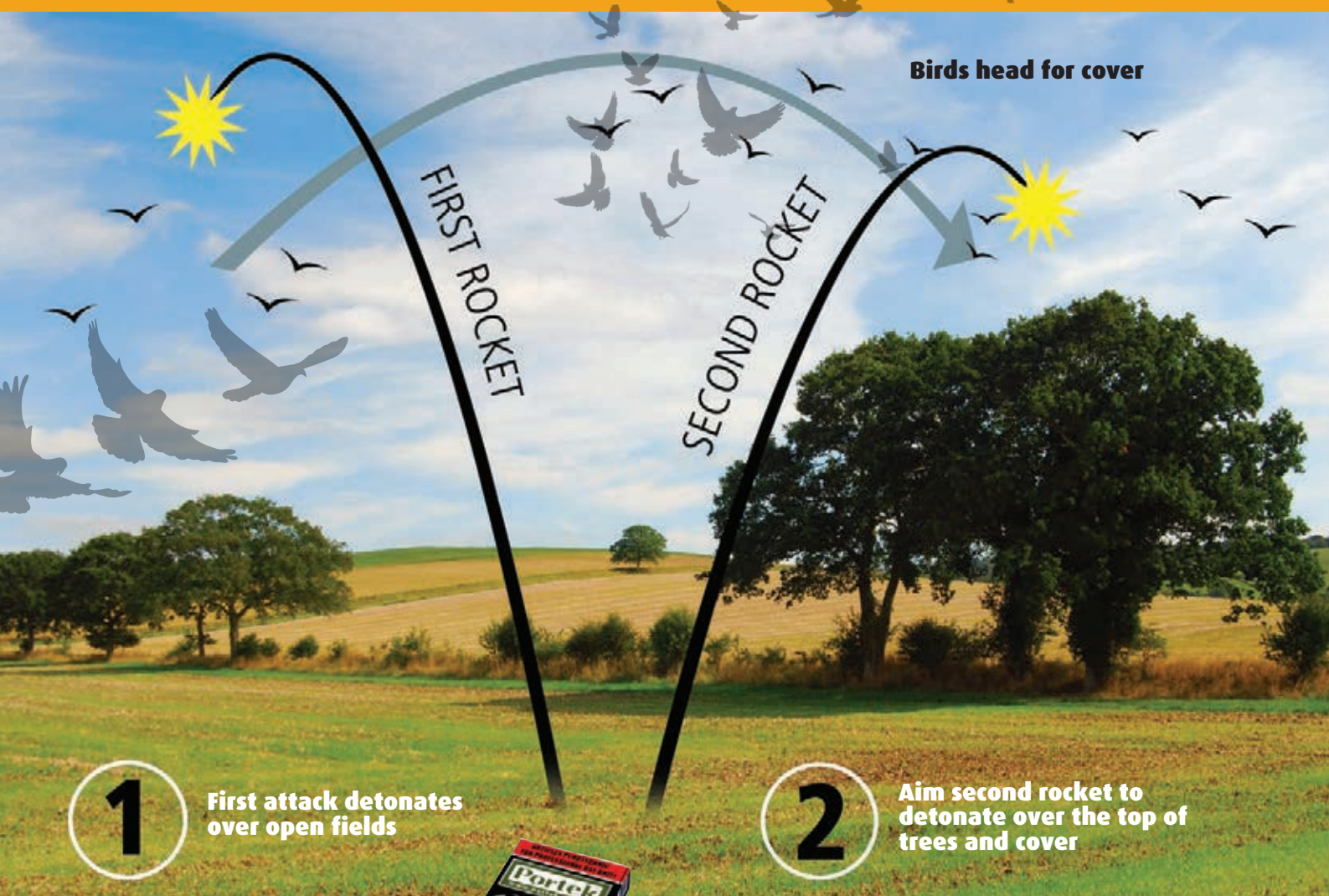

See the video at portek.co.uk



PART NUMBERS

Skybird Rockets 052 10 Rockets per box

Launched at an angle of between 45° to 60° by an out-of-view operator, the unexpected loud mid-air explosion ensures no return for many hours - especially if reinforced by a second rocket set off very soon after the first.

Birds become accustomed to all conventional bird scaring equipment if regular changes are not made in location and timing. Skybird Rockets are best used, not as a substitute for other methods, but to enhance their effectiveness by introducing a new element of shock and surprise.

Angle the launch tube (minimum 15mm diameter x 1 metre long) towards the birds; the optimum, safe angle is 60° to the ground. (Do not angle the launcher at less than 45° to the ground).

Ensure that there is at least 200 metres (600 feet) of unobstructed ground, clear of people, buildings, trees, haystacks or other hazards.



Explosives 1.3G - UN number 0430 - Articles, pyrotechnic for technical purposes. These are potentially dangerous items and must be handled with care, please read the instructions and follow them carefully.

Portek Banger Ropes



DESIGNED BY PORTEK

DOUBLE BANGER ROPES



| | |
|---------------------|-------------------|
| No of bangs: | 18 bangs per rope |
| Banger size: | 1.9" (50 mm) |
| Time between bangs: | Approx. 30 mins |
| Ropes per box: | 12 ropes per box |
| Rope diameter: | 0.7" (16 mm) |
| Rope length: | 40" (1015 mm) |
| Total burn time: | Approx. 6 hours |



Warning
Fire or projection hazard

Part No.
056

The double banger rope (every other bang is a double) is designed to emulate a shotgun in the field and make birdscaring more effective



Explosives 1.4G - UN number 0431 - Articles, pyrotechnic for technical purposes. These are potentially dangerous items and must be handled with care, please read the instructions and follow them carefully.

Birdscaring Banger Ropes

**CONTINUATION
BANGER ROPE**

**STANDARD DAY
BANGER ROPE**

1m (40") banging area

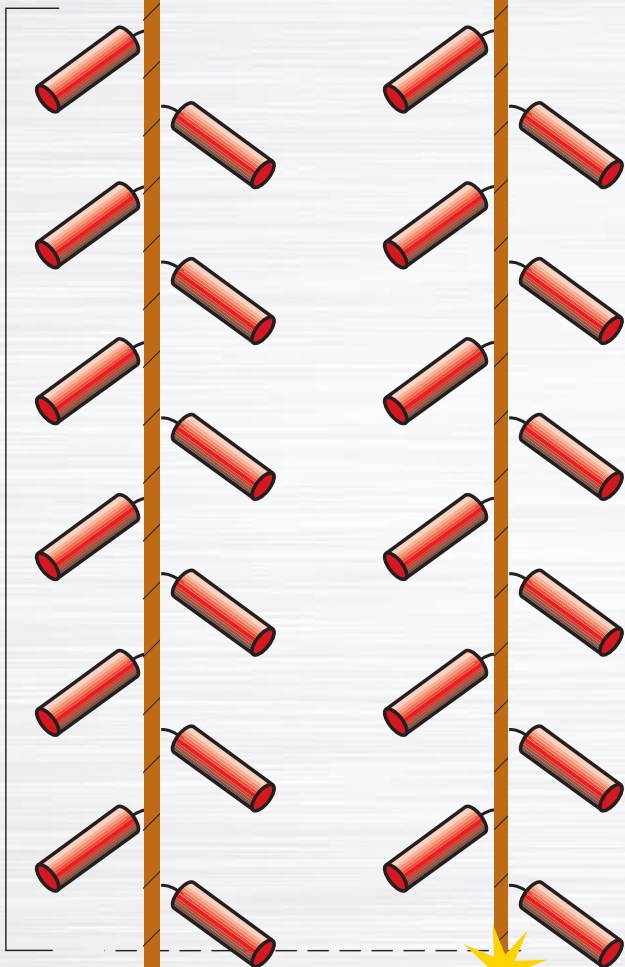

1m (40") long delay fuse

Part No.
051

CONTINUATION ROPES

| | |
|---------------------|-------------------|
| No of bangs: | 12 bangs per rope |
| Banger size: | 1.9" (50 mm) |
| Time between bangs: | Approx. 30 mins |
| Ropes per box: | 6 ropes per box |
| Rope diameter: | 0.7" (16 mm) |
| Rope length: | 80" (2030 mm) |
| Total burn time: | Approx. 12 hours |

Light a day rope and continuation rope at the same time and get 12 hours of protection

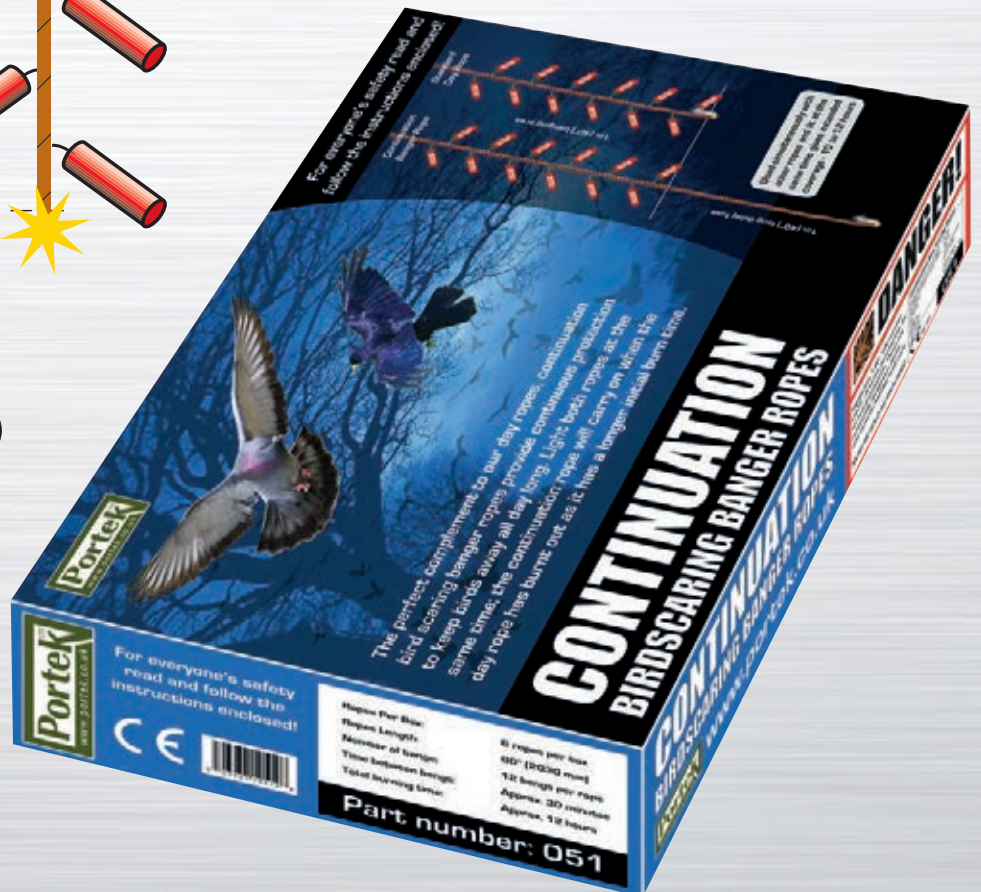

Warning
Fire or projection hazard

Hanging Crow Scarer

HANGING CROW SCARER

**A traditional but effective
economical bird scarer**



**Add more realism to
your bird scaring with
a realistic replica of a
dead crow**

Simply hang from a stake, fence,
hedgerow or tree for best results.

This replica crow will signal danger
to other birds. Initially, birds often
approach the corpse but usually leave
when they see the unnatural position
of the bird.

- A traditional method to scare birds away, trusted by farmers for centuries
- To keep the birds guessing, take the scarer down and move it to another location
- Easy to use - an economical and cost effective solution



DESIGNED BY PORTEK



**ECONOMICAL
DESIGNED TO LAST
FOR 1-2 SEASONS**

Part No.
038

**HAWK
EYES**

A proven and cost effective silent birdscarer. Perfect for agricultural crops, allotments, market gardens or anywhere that requires a quick and easy solution.

PART NUMBERS

Hawkeyes

038



See the video at
portek.co.uk

Sentinel

**HEAVY DUTY
EASY TO ASSEMBLE
DESIGNED TO LAST
MANY SEASONS**



SENTINEL

Wind driven birdscarer



Part No.
039

**RAISE AS YOUR CROPS GROW
FROM 82cm - 112cm**

4IN 1 ATTACK!

- 1 Large predator eyes**
- 2 Reflected light**
- 3 Nature's warning colours**
- 4 Movement**

**HEAVY GRADE
6mm STEEL TINES**



- ✓ Plated steel components
- ✓ Replaceable vanes
- ✓ Rust-proof nylon ball bearings
- ✓ Adjustable height

Wind Powered Birdscarers

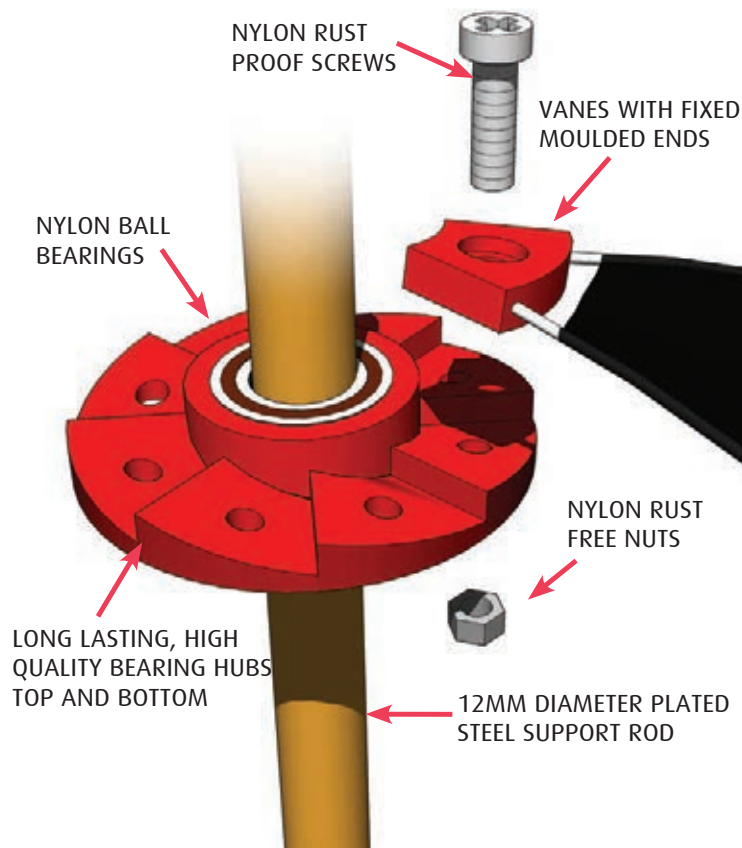

SIMPLE TO BUILD

- No glueing needed
- Quick & easy assembly
- No extra support needed
- Strong, freestanding tread-in forks
- Easy to move from field to field

Designed to last with great new features.
Proven birdscaring design.

Part No.
039/01

SIMPLE TO REPLACE VANES

8 spare vanes pack complete with pre-glued plastic ends and screws included: all you need to keep the Sentinel running from season to season.



DESIGNED BY PORTEK

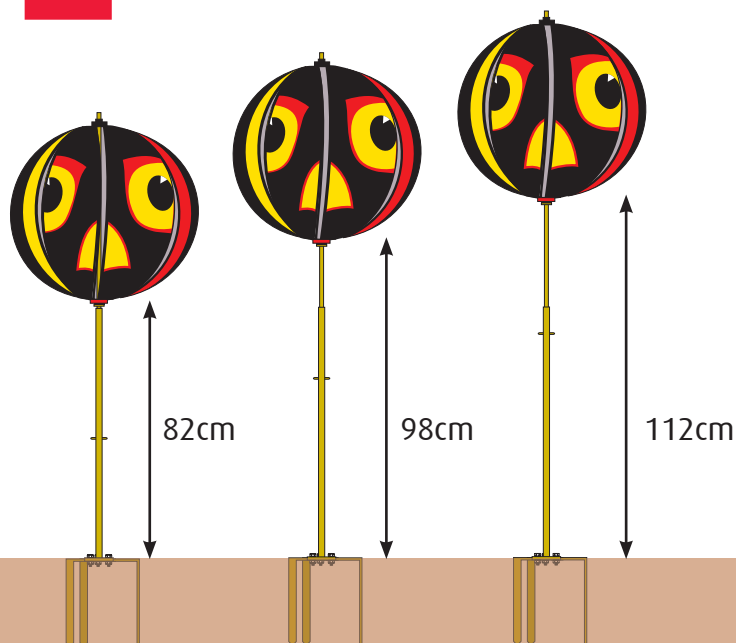

PART NUMBERS

| | |
|--|--------|
| Sentinel Bird Scarer | 039 |
| Sentinel Bird Scarer Spare Vanes pack of 8 | 039/01 |

ULTIMATE
LONG LIFE
PROTECTION

Disorientate the birds
with reflective flashing
movement as the
CROPGARD spins



CROPGARD

**Heavy duty
high quality
wind driven
birdscarer**

**High grade, robust
and brightly coloured
polypropylene blades**

Part No.
036



DESIGNED BY PORTEK



Wind Powered Birdscarers

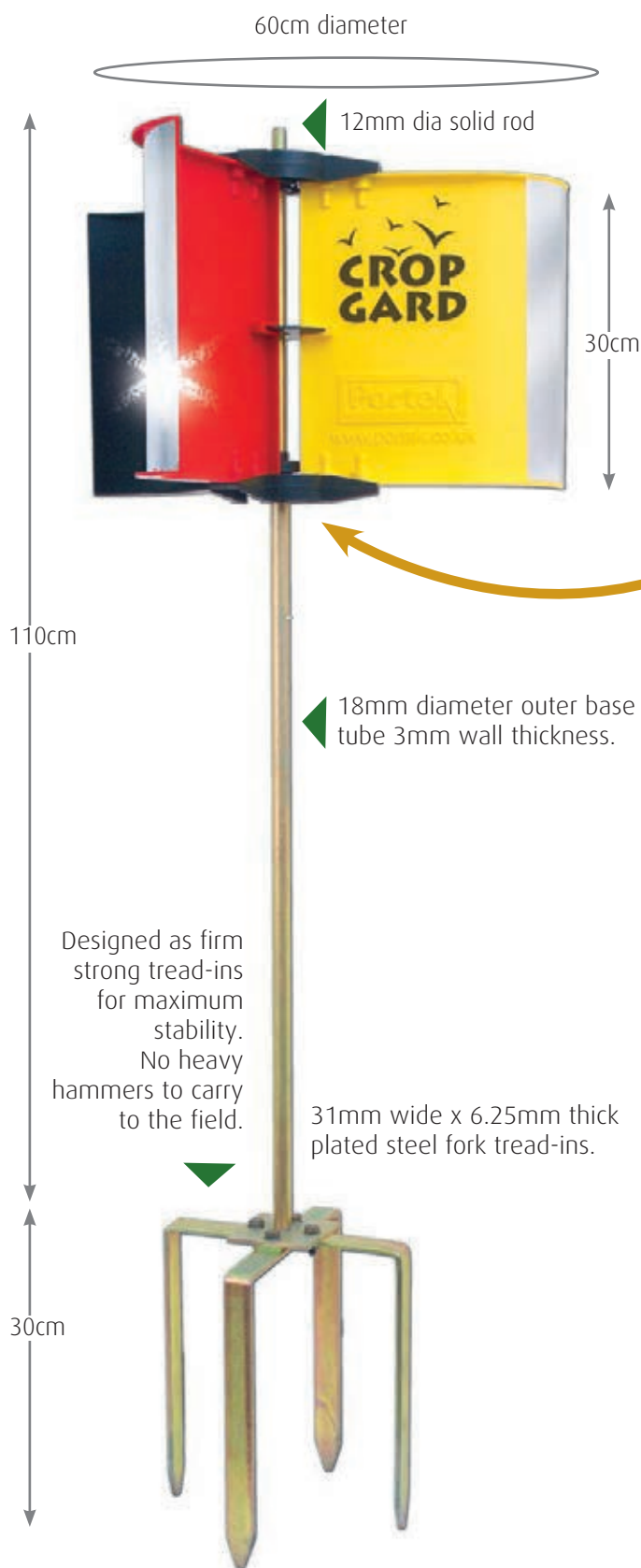

- Rust proof ball bearings
- Portable, easy to relocate
- Simply tread in the forks
- Very stable

Precision engineered built to last, high quality heavy duty construction

BIRDSCARING HANDY HINTS

Use bright colours
Reflective flashes shock birds
Random movement distracts birds
Relocate the scarers frequently
Keep birds guessing by using different methods

PART NUMBERS

Cropgard

036

Hunter Birdscarer

THE HUNTER

ADD REALISM TO YOUR BIRDSCARING

NEW THIS SEASON

Part No.
040

FOR EXTRA
EFFECT USE
BANGER ROPES

This lifesize birdscarer
moves gently in the
direction of the wind

- All steel construction - weighs 15Kg
- Plated reflective steel to catch the light
- Turns easily and gently on ball bearings
- Robust tread-in stake and heavy duty anchor plates for stability

**RUST-PROOF
YELLOW ZINC
PASSIVATED
STEEL**

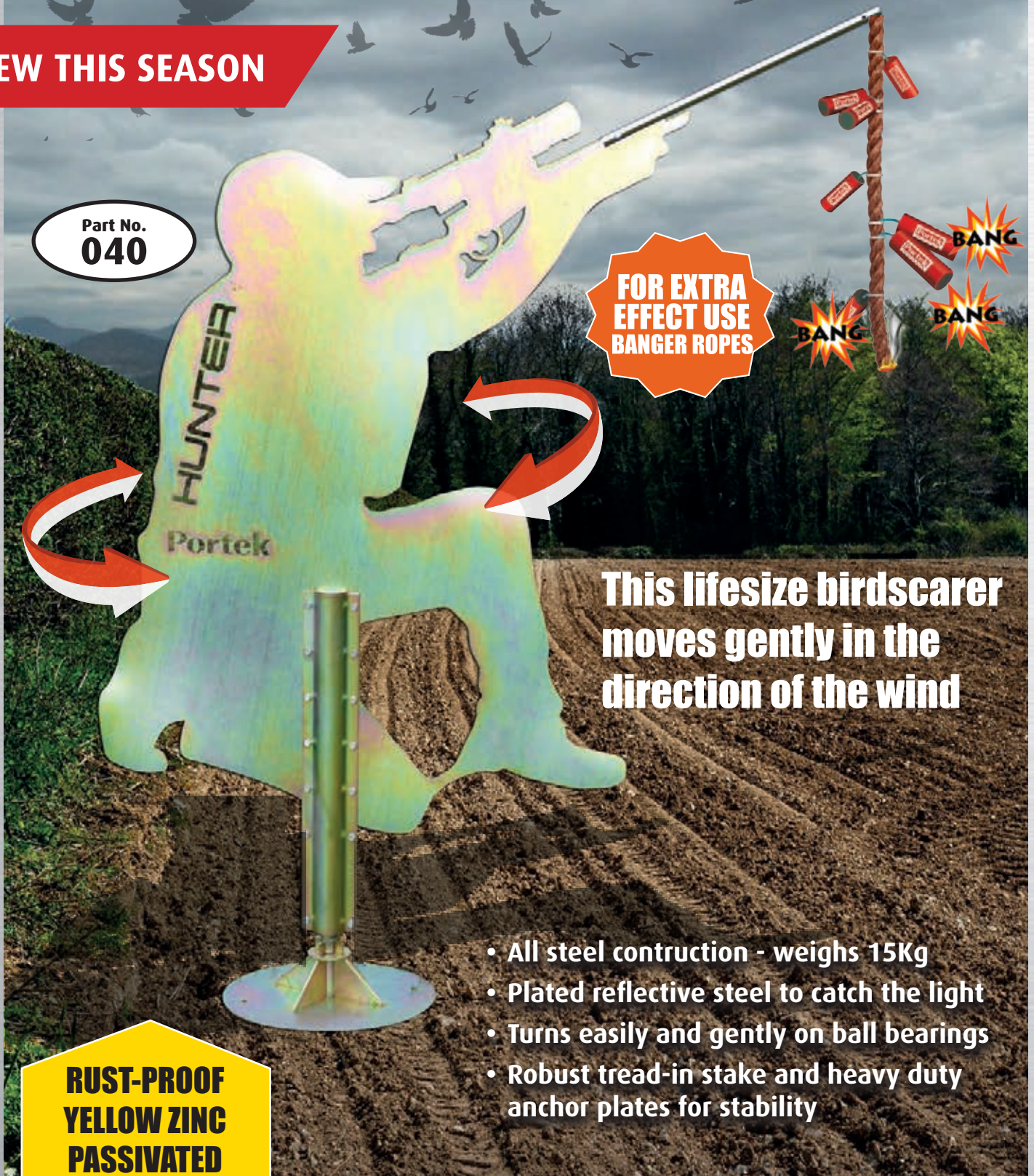

Wind Guided Birdscarer

It's a well known fact, when a farmer walks into a field carrying a gun, the birds disappear; Hunter is the solution!



DESIGNED BY PORTEK



HANG BANGER ROPES FROM BARREL

PAINT YOUR OWN!

1530 mm (5ft)



HEAVY DUTY SEALED BALL BEARING

PLATED STEEL MAIN SUPPORT ROD

HEAVY DUTY SEALED BALL BEARINGS

EASY TREAD-IN BASE WITH STRENGTHENING FINS AND POINTED STEEL STAKE

For added realism, if required, change the colours each season to keep the birds guessing; some ideas above. Use any waterproof paint and your imagination!

PART NUMBERS

The Hunter

040

Terror Kite & Terror Hawk



TERROR HAWK

Terror Hawk

This kite hovers menacingly like a hawk



TERROR KITE

Terror Kite

This kite swoops & dives and is constantly moving



DESIGNED BY PORTEK

Quiet and extremely effective, Terror Kite and Terror Hawk are always on patrol even in the lightest breeze.

Birdscaring Kites



See the video at
portek.co.uk



Terror Kite

Complete kit
(Part No. 037)

**Both kites in one convenient pack...
switch and choose for optimum effect**



CONTENTS

- 1x Terror Kite
- 1x Terror Hawk
- 7m Telescopic Launch Pole
- Strong Line and Swivels
- Groundstake
- Support Disc
- Full Instructions

PART NUMBERS

| | |
|--------------------------|--------|
| Terror Kite complete kit | 037 |
| Terror Kite spare kite | 037/01 |
| Terror Hawk spare kite | 037/02 |

The reflective eyes, predator colours and constant flashing movement clears the birds.

BirdYell Birdscarer

BIRD

YELL

Powerful audio bird scarer emulates a bird under attack

Part No. **058**
WITHOUT REMOTE



Part No. **059**
WITH REMOTE

BIRD

YELL



BirdYell + includes a great remote control unit to make the BirdYell even easier to operate

Hand-held audio scarer



Multiple sound options and features

Replicating the sound of birds that are under attack from predators or the sound of the threat itself, is a very effective way to clear birds from **farm buildings, cowsheds** and **grain stores**.



All these sounds as standard

| | |
|----------------|-------------------|
| Starling | Sparrow hawk |
| Jackdaw | Kestrel |
| Crow | Herring Gull |
| Canadian Goose | Black headed Gull |
| Greylag Goose | Common Gull |
| Barnacle Goose | Wolf Howls |
| Jay | Shotgun |



Technical data:

| | |
|---------------|---|
| Power: | 10 x AA batteries or 12 volt car battery, cables supplied |
| Output: | Built in speaker 10W |
| Frequency: | 20Hz - 20Khz |
| Max sound: | 110 dB |
| Working temp: | -40 to 80 °C |
| Size: | 20cm x 10cm x 14 cm |
| Weight: | 770 gm |
| Ip rating: | 50 (unit works in dusty conditions, not waterproof) |

Remote control unit

| | |
|--------|-------------------|
| Power: | 3 x AAA batteries |
|--------|-------------------|

THIS IS LOUD!
EAR PROTECTION ESSENTIAL



PART NUMBER

| | |
|-------------------------------------|-----|
| BirdYell scarer | 058 |
| BirdYell scarer with Remote Control | 059 |

Laserstrike

You'll be amazed at the effectiveness...

LASER·STRIKE

www.portek.co.uk

BIRD SCARING LASER



DESIGNED BY PORTEK

CONTENTS

- Quality carrying case
- Laserstrike birdscarer
- 2 x 2400 MAh rechargeable batteries
- 2 x keys for secure use
- Battery charger
- User guide

CE APPROVED



See the video at
portek.co.uk

Part No.
057



- **Portek's unique large 100mW diode ensures effectiveness even on bright sunny days**

Hand-held Birdscaring Laser



Clears large areas in minutes

LASERSTRIKE IS MANUFACTURED FOR PROFESSIONAL USE ONLY (laser classification 3B). Not to be confused with cheap, low power lasers that have low beam quality and are considerably less effective on very bright days.

The **LASERSTRIKE** has been specifically developed for use as a safe, effective birdscaring tool and uses high quality precision lenses and components.

LASERSTRIKE is designed to scare and clear birds at close range and at distances of up to 500m. It is most effective when used in low light conditions (ie winter) and at dawn and dusk when the birds are most active.



- Silent and highly effective against most species.
- Tests have shown that repeated use over 3 to 10 days will substantially reduce or eliminate the target species.
- Occasional follow-up may be required to maintain deterrent effect.
- Perfect close to built-up areas where noise complaints can be an issue.



PART NUMBERS

Laserstrike

057



Seagulls



Woodpigeons



Crows and rooks



Starlings

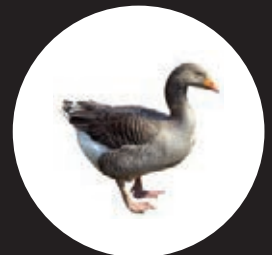

Geese



Cormorants

Original Cow Clog



Part No.
012

The **ORIGINAL**
COW CLOG



30 YEARS OF HAPPY COWS!

Hoof Support

Hoof support for a speedy recovery from lameness!

10 HOOF TREATMENT



The adhesive has two pre-measured components making mixing simple. Once the adhesive is mixed and applied to the cow's claw, the clog is placed into position and the adhesive is moulded into a 'Boot' around the block and cow's claw.

A chemical reaction takes place hardening the adhesive and securing the wooden block to the cow's claw.

The Original Cow Clog - proven performance over the years has made this one of the best selling treatments for lameness.



**DESIGNED AND MADE
BY PORTEK**

PART NUMBER

Cow Clog Original (10 treatments)

012

Logmaster - often copied . . .

 **DESIGNED
BY PORTEK**

LOG *master* **HEAVY DUTY SAW HORSE**

**STRENGTH | QUALITY
STABILITY | SAFETY**

Part No.
090

See the video at
portek.co.uk

**Only the
ORIGINAL
LOGMASTER
weighs in at a
hefty 17 kg!**



The safest and strongest chainsaw log bench available

. . . but never bettered



Work fast and safely



Simply rotate, the bench takes the weight of the chainsaw



Less chance of back ache!

- ✓ Fully adjustable for large/small logs
- ✓ 2mm thick plated steel construction
- ✓ Heavy Duty 17kg weight
- ✓ Huge load capacity - 125kg!
- ✓ Ultra safe chainsaw clamp
- ✓ Telescopic adjustable legs
- ✓ Guarded chain bar

PART NUMBER

Original Logmaster

090

Post Driver

NEW THIS SEASON



Part No.
075

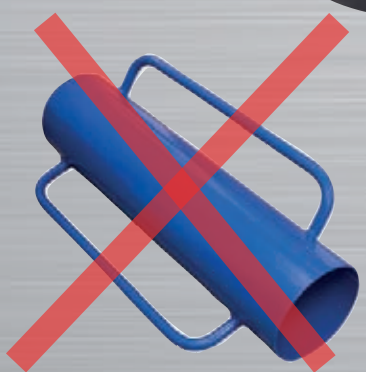

No more
hard work
or backache

**Amazing new
post driver
powers fence
posts into
the ground
with ease
in seconds**



Post Driver

POST DRIVER



Post Driver comes with

3 piling socket adaptors: 20mm - 49mm, 50mm - 69mm and 70mm - 100mm. Lubricating grease (60g).
Instruction booklet and toolkit, all in a strong abs plastic case.



20mm - 49mm (0.75" - 2")
50mm - 69mm (2" - 2.75")
70mm - 100mm (2.75" - 4")

Piling socket adaptors up to 4"

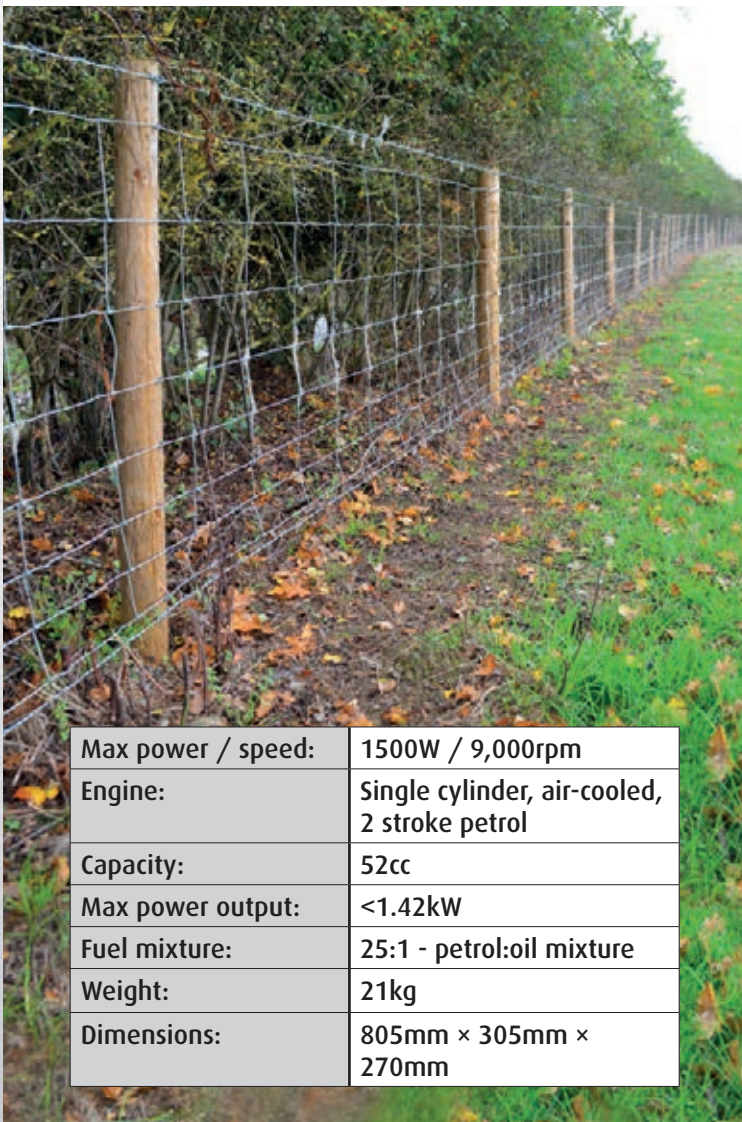

| | |
|--------------------|--|
| Max power / speed: | 1500W / 9,000rpm |
| Engine: | Single cylinder, air-cooled, 2 stroke petrol |
| Capacity: | 52cc |
| Max power output: | <1.42kW |
| Fuel mixture: | 25:1 - petrol:oil mixture |
| Weight: | 21kg |
| Dimensions: | 805mm × 305mm × 270mm |



PART NUMBER

Post Driver

075

Charger 8.5 Ton



DESIGNED BY PORTEK
Patent Pending - fully compliant



**x10 faster than
hydraulic splitters**



**This revolutionary
machine will change the
way you split logs forever**

8.5 TON IMPACT LOG SPLITTER

Log Splitter



No tiring crouching & waiting
as with slow hydraulic machines



Part No.
100

The Charger 8.5 ton impact log splitter uses kinetic energy to split logs in an instant. With a cycle time of under one second, this is truly the fastest log splitter you've ever seen. It works as fast as you do, with no waiting around.

SPLITS A LOG IN A *SPLIT* SECOND!

Charger 8.5 Ton

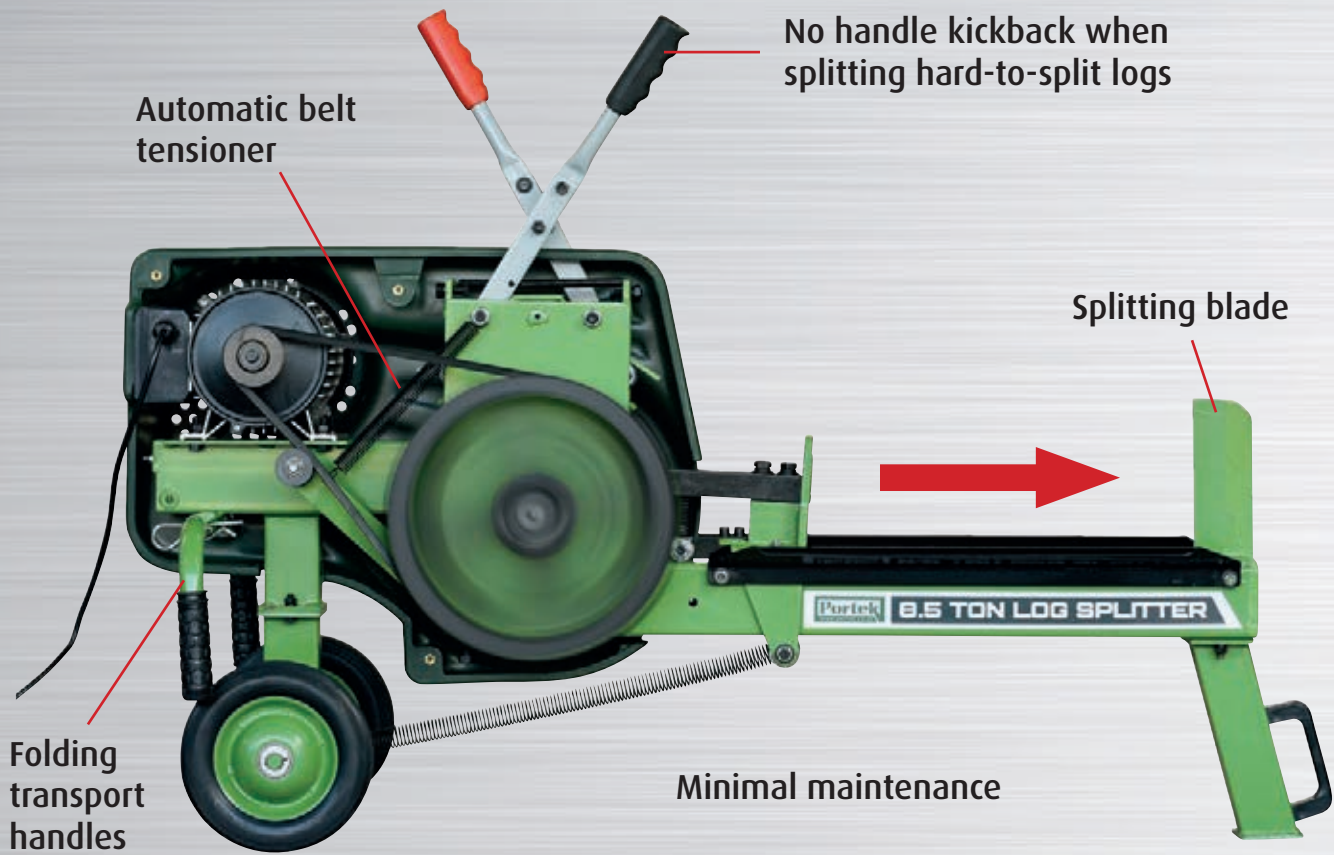

The powerful 1.5 kW electric motor powers the heavy flywheels to release the equivalent of 8.5 tons of stored energy which drives the ram to split logs in a split second!



Log Splitter



ALL NEW PORTEK DESIGN

CE APPROVED

**Ultra safe, the ONLY
impact splitter that
is compliant with CE
standards**

| | |
|----------------------|--|
| Size | 107 x 32 x 57cm |
| Power / Voltage | 1.5 KW / 220-240volt |
| Log Capacity | Max Length: 400mm Max Diameter: 300mm |
| Max. splitting force | 8.5 Ton |
| Nett weight | 73.0 Kg |



PART NUMBER

Charger Log Splitter

100

Log Splitting Axes

High quality hickory handled log splitting and kindling axes

Splitting Axe

BOTH AXES IN ONE PACK



Part No. **090/15**

Kindling Axe

PART NUMBER
2 Pack Axe Kit 090/15

The perfect complement to our Heavy Duty Logmaster Sawhorse

ChainSharp 12v Chainsaw Sharpener

ChainSharp
12v Chainsaw Sharpener



Part No.
091

- Hand held 12V mini chainsaw sharpener
- Connects to any 12V battery
- 12 volt, 24000 rpm motor

The ChainSharp is a compact, hand held 12V electric powered chainsaw sharpener, designed to sharpen most types of chainsaw chain. It's great value for money and can be used anywhere, at home or in the field.

The ChainSharp electric chainsaw sharpener is supplied with three different size grinding stones, tools and cables.



**Easy to connect to
any 12 volt battery**

Part No. 091/01
4.8mm - 3/16" fits
chain with .325 pitch



Part No. 091/02
4.0mm - 5/32" fits
chain with 1/4 pitch chain
or 3/8" low profile chain



Part No. 091/03
5.5mm - 7/32" fits
chain with 3/8" pitch



PART NUMBERS

| | |
|-------------------------------------|--------|
| 12V ChainSharp | 091 |
| Replacement sharpening stones 4.8mm | 091/01 |
| Replacement sharpening stones 4.0mm | 091/02 |
| Replacement sharpening stones 5.5mm | 091/03 |

FlexiSharp ChainMaster



DESIGNED BY PORTEK

Rechargeable autoclamp chainsaw sharpener

Perfect for working away from a power supply

Another first from Portek!

Unique Portek design automatically clamps the chain when lowering the sharpening disc



Part No. 098

NEW THIS SEASON

Rechargeable Li-ion battery provides longlasting power in the field

Chainsaw Sharpener

At last a cordless autoclamps chainsaw sharpener with all the power you need



Adjustable cutting angles from -30° to $+30^\circ$

Li-ion battery powered



Quick battery change over - simply press to release old and push-click new battery

LI-ION BATTERY

| | |
|-----------------|--------------------|
| Capacity: | 1.5 Ah |
| Input Voltage: | 21V |
| Output Voltage: | 18V |
| Power: | 50W |
| Speed | 6500 rpm - no load |



Clamps chain automatically as the sharpening wheel is lowered



4.5mm and 3.2mm replacement sharpening wheels available

PART NUMBERS

| | |
|------------------------------------|--------|
| FlexiSharp Sharpener | 098 |
| Replacement sharpening wheel 4.5mm | 092/01 |
| Replacement sharpening wheel 3.2mm | 092/02 |

Maxi ChainMaster MK2



The Maxi ChainMaster MK2 sharpener is designed for the frequent and professional user and is fast and easy to use.

**AUTOMATICALLY
CLAMPS THE CHAIN
WHEN SHARPENING**

Part No.
092A



- Adjustable 0 - 35° cutting angle
- Motor: 240v, 85W, 5300 rpm
- Replaceable sharpening wheels:
4.5 mm or 3.2 mm thickness

Chainsaw Sharpener



PART NUMBERS

| | |
|------------------------------------|--------|
| Maxi ChainMaster Mk2 | 092A |
| Replacement sharpening wheel 4.5mm | 092/01 |
| Replacement sharpening wheel 3.2mm | 092/02 |

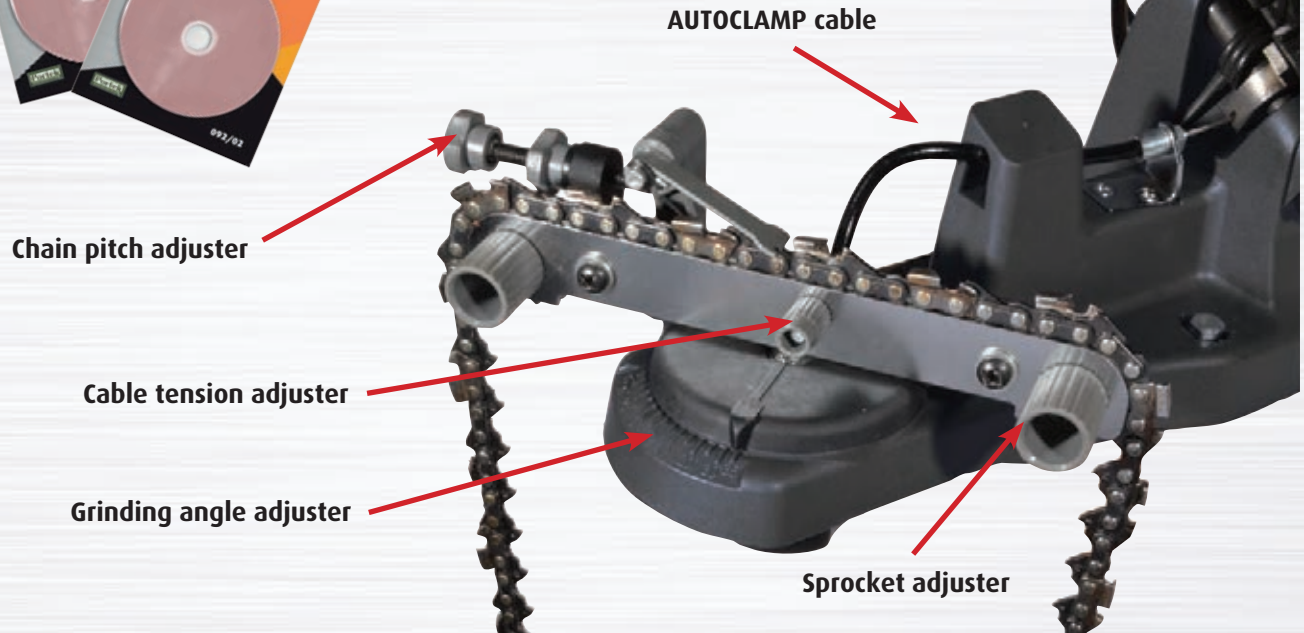

AUTOCLAMP: How it Works



**CHAIN IS CLAMPED AUTOMATICALLY
AS THE SHARPENING WHEEL IS
LOWERED ONTO CHAIN**



Ultra ChainMaster MK3



The machine for the professional user. This fully adjustable, workshop quality model is robust enough to deal with prolonged use.

The integral light helps to get the perfect cutting edge everytime.

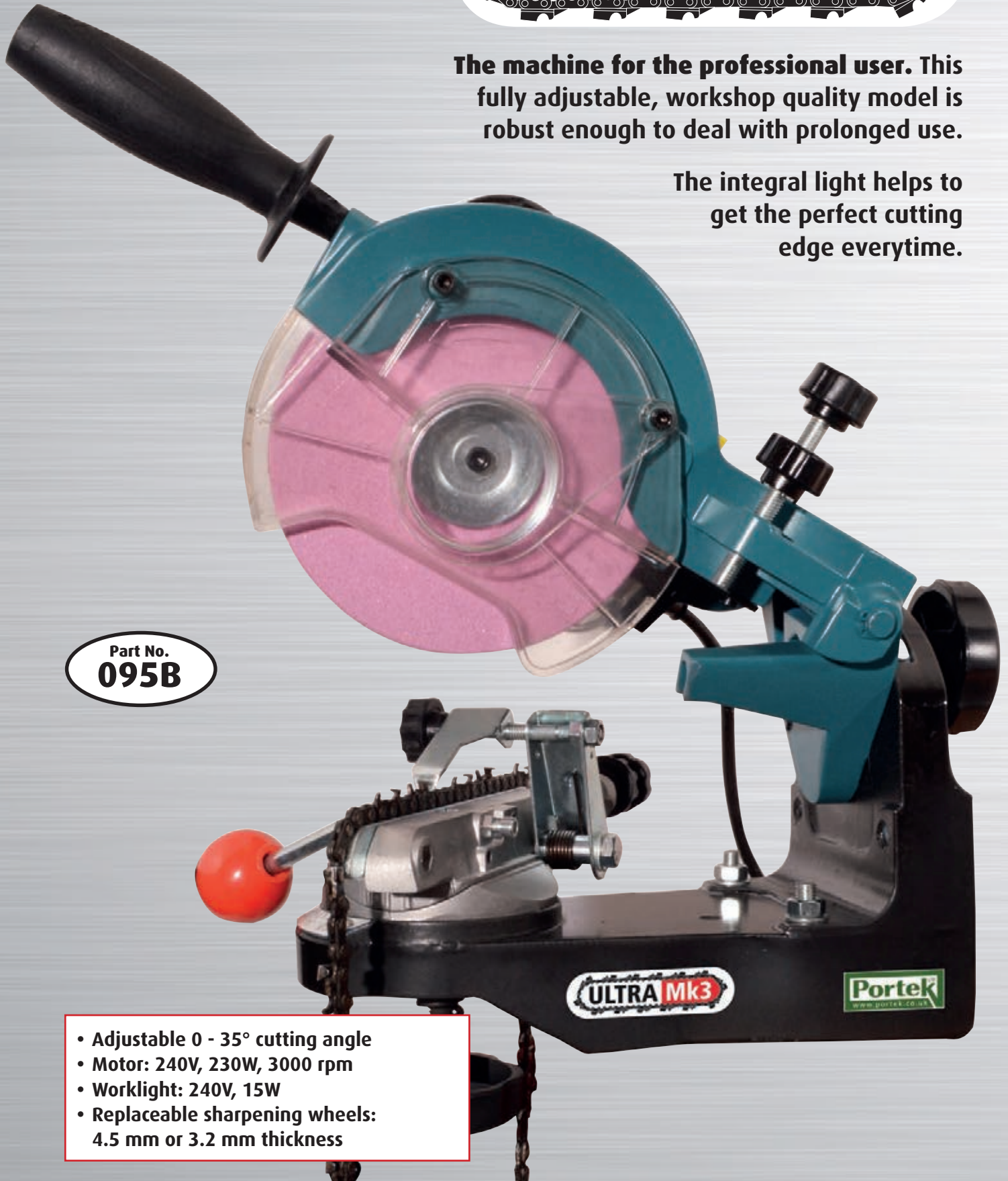

Part No.
095B

- Adjustable 0 - 35° cutting angle
- Motor: 240V, 230W, 3000 rpm
- Worklight: 240V, 15W
- Replaceable sharpening wheels:
4.5 mm or 3.2 mm thickness

Chainsaw Sharpener

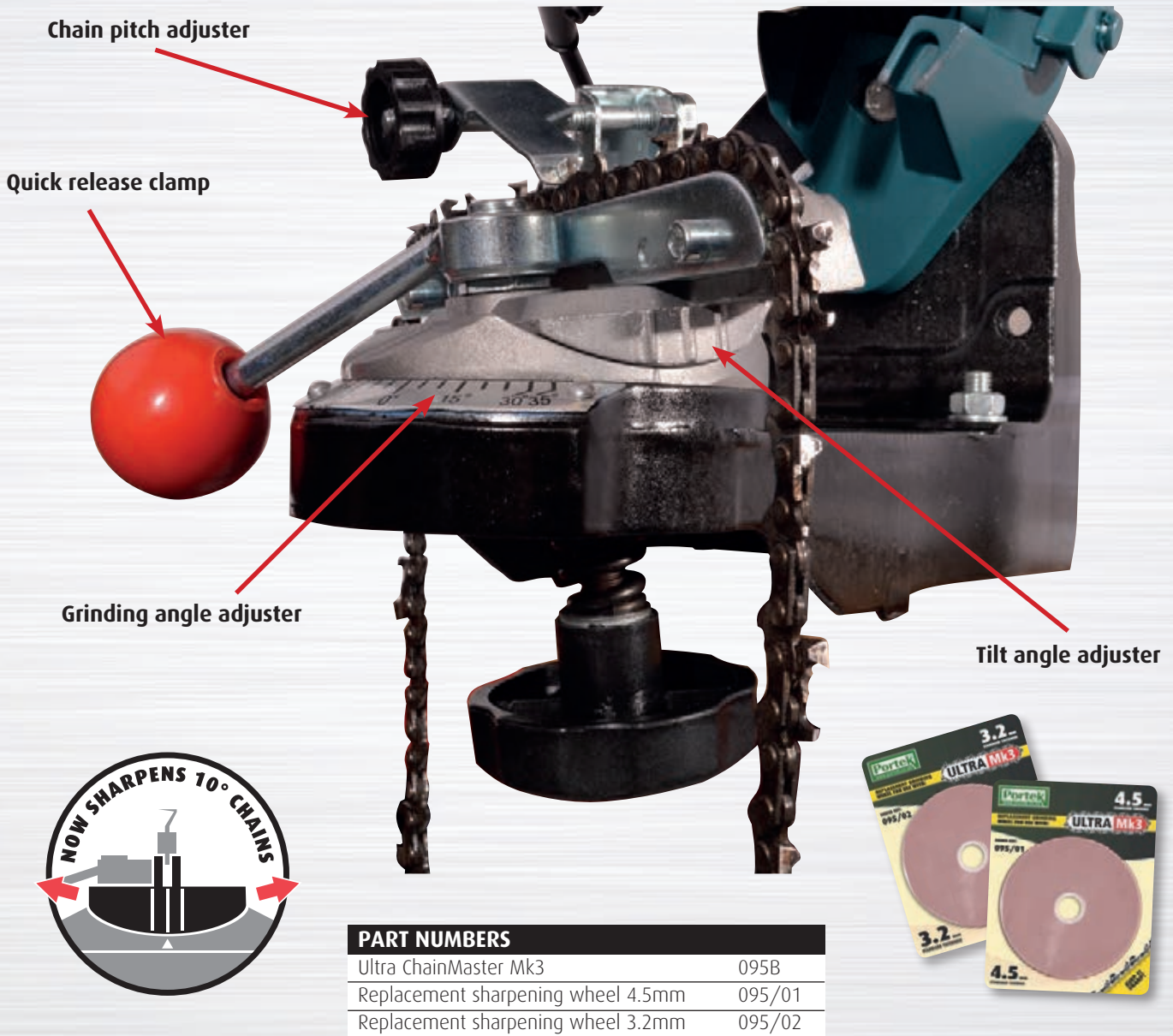

PART NUMBERS

| | |
|------------------------------------|--------|
| Ultra ChainMaster Mk3 | 095B |
| Replacement sharpening wheel 4.5mm | 095/01 |
| Replacement sharpening wheel 3.2mm | 095/02 |

Precision Adjustment

The Ultra ChainMaster MK3 sharpener offers the user unrivalled precision when it comes to keeping your chainsaw sharp - the new adjustable cradle is able to sharpen 10° chains.

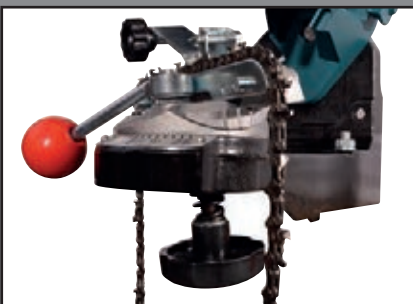

10° Tilt Angle



0° Tilt Angle



10° Tilt Angle

NEW THIS SEASON

FLEXI•VICE

- Heavy duty, multi-functional vice
- 127mm - 5" standard vice clamp
- Large diameter pipe clamp jaws
- Two way 360° rotation allows for secure work at any angle

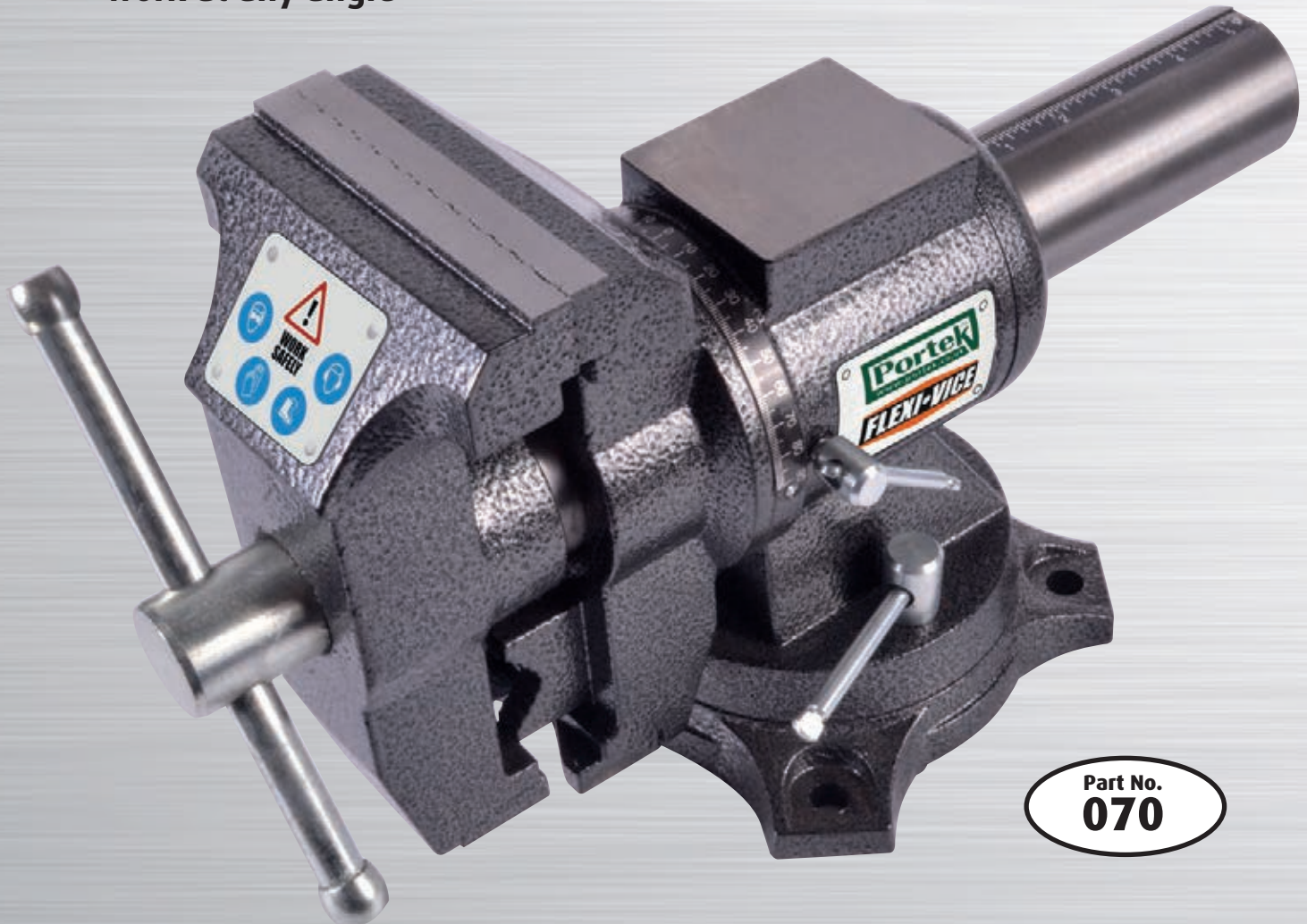

Part No.
070

THE ULTIMATE HEAVY DUTY VICE FOR YOUR WORKSHOP

Ultimate Workshop Vice



Clamp options



Large Diameter Pipe Clamp
jaws open 127mm (5")

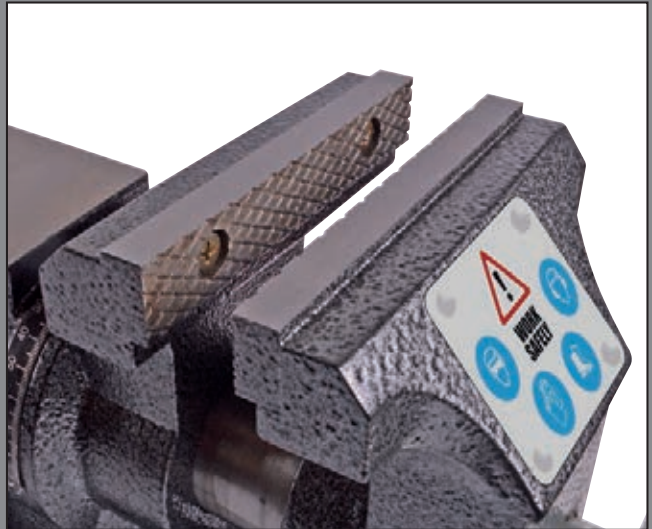

Standard Vice Clamp
127mm (5")

PART NUMBER

FlexiVice

070

Powerstrim



Suitable for all straight shaft brushcutters

Powerstrim 4

For machines 0.5 kW (18cc) and above:

- Fits all straight shaft anti-clockwise rotation Brush Cutters and Strimmers designed to take a steel blade
- Uses any gauge of nylon line
- Hard wearing and long lasting
- Ideal for medium to heavy duty machines
- Multiple lines ensure slow wear rate
- Ultra simple and fast 'twist & lock' line changing



Powerstrim 4Pro

For machines 1.3 kW (30cc) and above:

- Ultra hard wearing heavy duty aluminium construction multi-line head
- Fits all straight shaft anti-clockwise rotation Brush Cutters and Strimmers designed to take a steel blade
- Uses any gauge of nylon line
- Hard wearing and long lasting
- Ideal for medium to heavy duty machines
- Multiple lines ensure slow wear rate
- Ultra simple and fast 'twist & lock' line changing



Powerstrim 6 - the mulching head

For machines 1.5 kW (36cc) and above:

- Fits all straight anti-clockwise rotation Brush Cutters and Strimmers designed to take a steel blade
- Unique 3 tier line cutting design
- Cuts, mulches and scatters leaving a clean finish
- Uses any gauge of nylon line
- Simple and fast line changing
- Tackles heavy jobs with ease

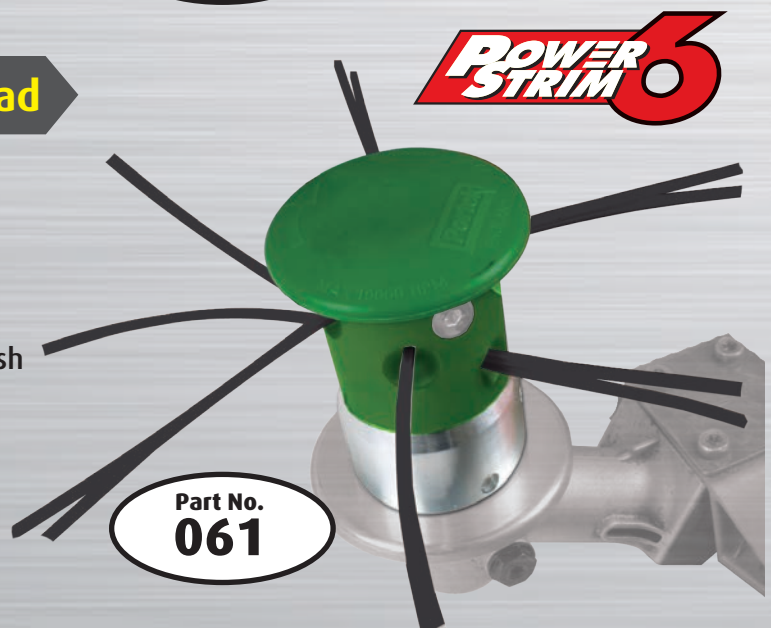

Strimmer Heads & Replacement Line



High quality replacement brushcutter line

High quality square & star profile precut nylon line for use with our Powerstrim strimmer heads.

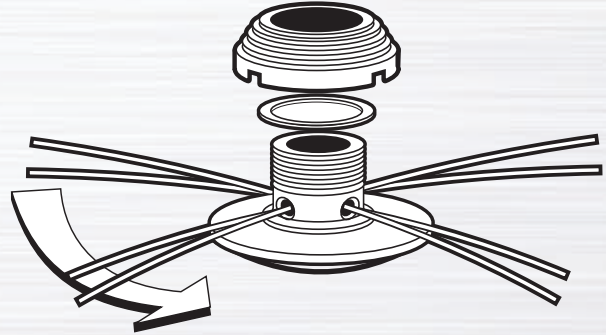
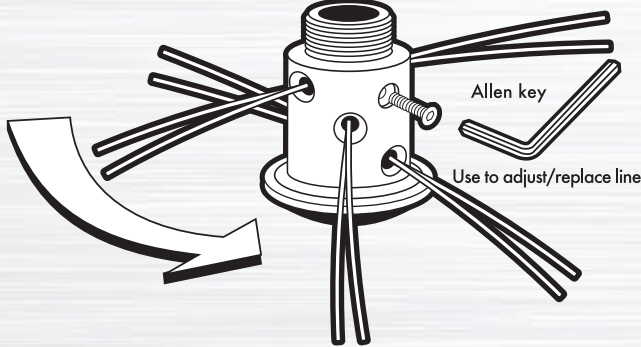
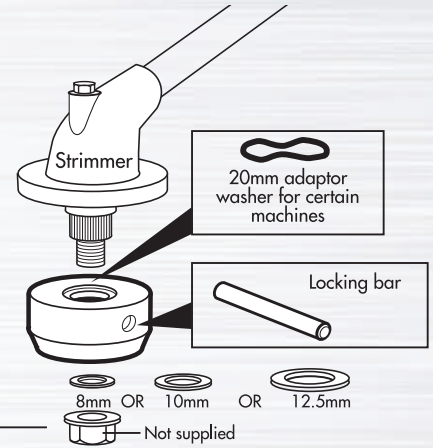
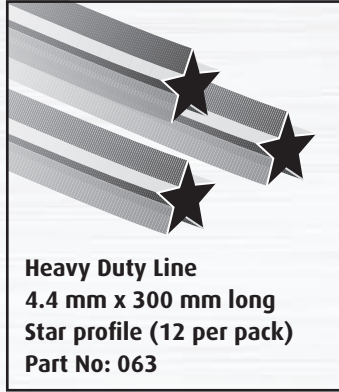
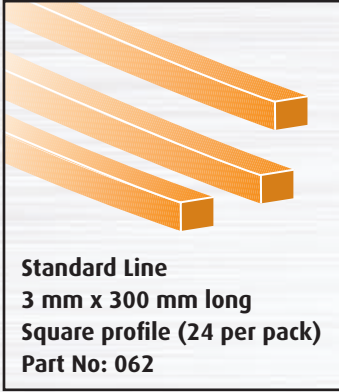

Universal head for 1.3kW (30cc) and above:

- Heavy duty bump feed head
- Quick and easy line loading
- No dismantling
- Universal fitting
- Metal bump button

Part No. **085**





Wheeled brushcutter total flexibility



DESIGNED AND
ENGINEERED
BY PORTEK

**SOLID NO
PUNCTURE
TYRES!**

Part No.
027

Powerful 52cc two stroke
engine wheeled brushcutter

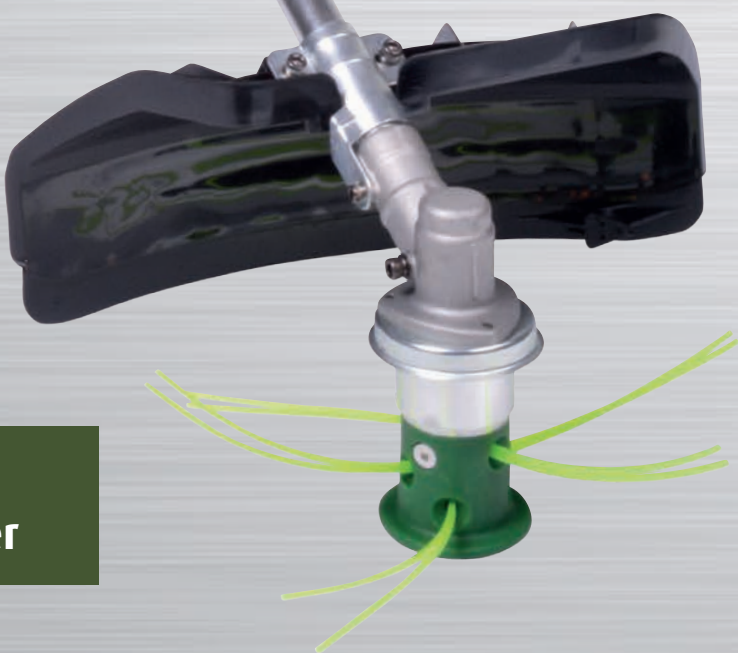

Wheeled Brushcutter



The RufCut wheeled brushcutter is ideal for clearing heavily overgrown areas.

It's unique Flexi-Cut system allows cutting right up to walls and edges.

All this without putting a strain on your back to allow you to work longer.

Supplied with our Powerstrim 6 mulching head



Compatible with all our Powerstrim range of heads



**Fast as a brushcutter
Easy as a mower!**



The RufCut Brushcutter features our Flexi-Cut system which allows easy cutting right up to walls and edges with a simple adjustment

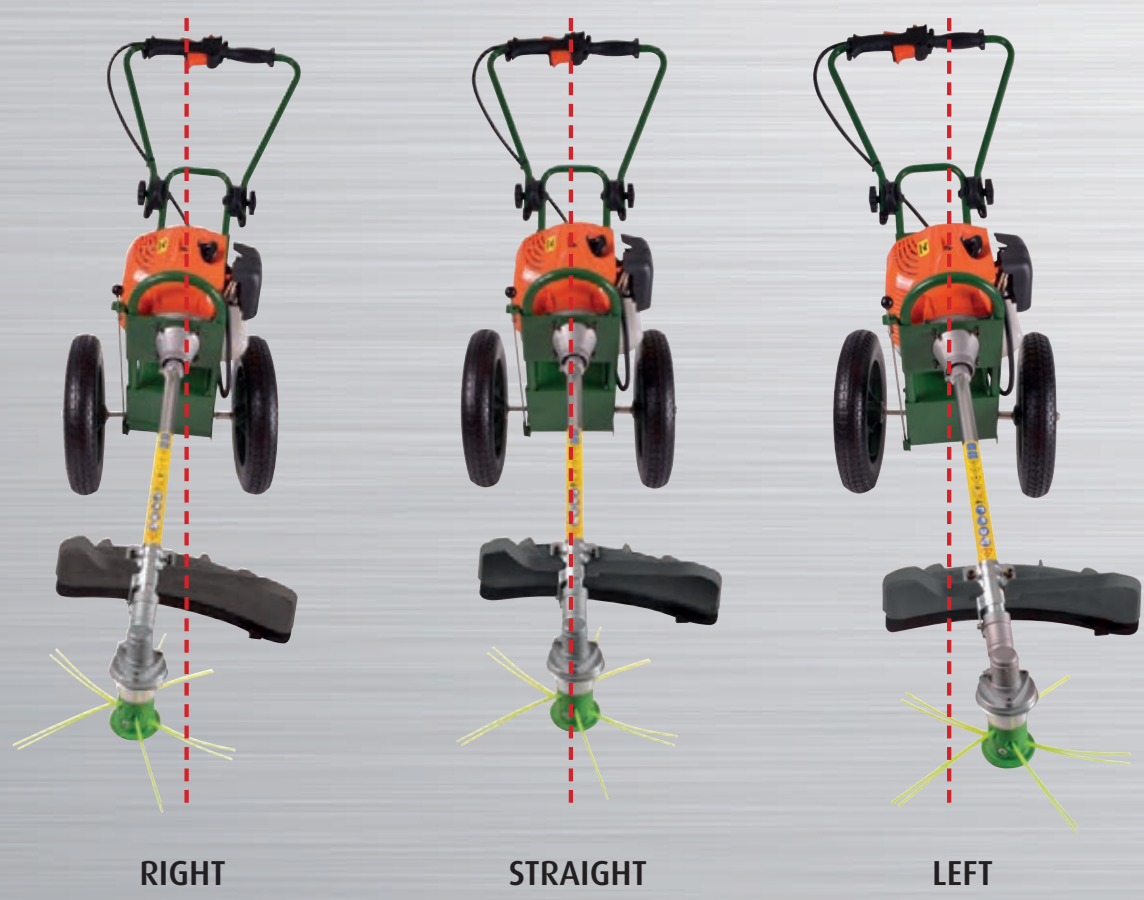

Wheeled Brushcutter



See the video at
portek.co.uk



Flexible handle to allow
working on a slope and
comfort of operator



SPECIFICATIONS

Engine: Air cooled 2 stroke petrol

25:1 ratio mix

52cc - 1.47 kW

Automatic centrifugal clutch

Recoil type starter

Electronic ignition

Trolley: Solid, puncture-proof tyres

Swivel axle - Flexi-Cut control

Built in toolbox

Double grip and cut out switch

Adjustable handle



Supplied with toolkit



Folds for transport & storage

- Reduces backache
- Powertrim 6 head included
- Easy to transport and store
- Puncture proof tyres
- Full range of spare parts available

PART NUMBER

Rufcut Wheeled Strimmer

027

Tripod Garden Sprinkler

TRIPOD GARDEN SPRINKLER

- Provides up to 12m range when at maximum height
- Fits all standard garden hose connectors
- Camera quality telescopic tripod

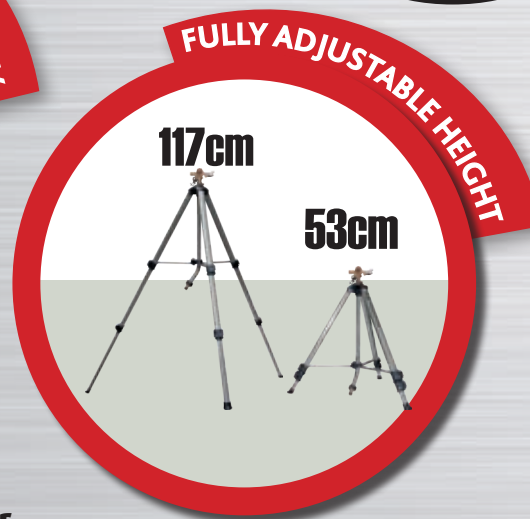

Part No.
065



- Telescopic legs allow for adjustable height: 53cm - 117cm
- Increasing the height, increases spray reach up to 12m diameter
- Tripod legs provide stability on uneven ground
- Compact for easy storage



PART NUMBER

Tripod Garden Sprinkler

065

Oscillating Garden Sprinkler

NEW THIS SEASON



HEAVY DUTY LONG LASTING ALL METAL BASE

- Oscillating sprinkler featuring 17 brass nozzles for maximum spray pattern
- fan-shaped curtain of water oscillates back and forth to cover an area of 28m² - 350m² (up to 3,600 Sq. ft)
- High quality, metal components for increased durability
- 1.2 kg metal base for greater stability
- Fits all standard garden hoses connectors

**A GARDEN SPRINKER
THAT'S BUILT TO LAST**



Simple control dial adjustment

PART NUMBER

Oscillating Garden Sprinkler

066

Boutafoam Field Marking Fluid

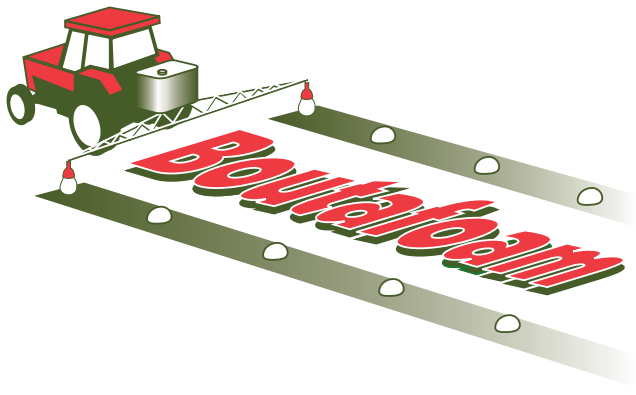

Part No.
020



For use with the
Portek Foamalign
system to prevent
uneven spraying

| PART NUMBER | |
|------------------------------------|-----|
| Boutafoam Field Marking Fluid 2.5l | 020 |



Chemdrip Drainage Tray



Part No.
044



**DESIGNED AND
ENGINEERED
BY PORTEK**

The Chemdrip Tray is used to drain your **triple rinsed chemical containers** ready for collection & recycling. Perfect for dairy chemicals and oil containers too.

How it Works

Effective drainage of wide neck containers.
Patented cones can be arranged as required.



“ 40% of pesticides reaching water are thought to come from handling areas. ”

* NRoSO ProOperator February 2011

Portable - only 5.5kg!
Complete pack includes
5 large and 5 small cones.

DON'T RISK HUGE CONTAMINATION FINES, COMPLY WITH NRoSO REGULATIONS

Chemdrip



**DESIGNED AND
ENGINEERED
BY PORTEK**

Chemdrip Spill Bund



Part No.
044/04



Catches spills and splashes under your sprayer filling areas. Perfect for chemical and oil leaks in chemical stores and workshops.

Be seen by the ACCS Inspector to be doing all you can to reduce the risk of spillage and contamination!



| PART NUMBERS | |
|---|--------|
| Chemdrip Drain Tray including 5 large and 5 small cones | 044 |
| Chemdrip Bund | 044/04 |

COMPLY WITH EVER INCREASING LEGISLATION

Always be safe using our equipment. The recommendations below are intended to be a general guide and may not apply to every Portek product. All of our instruction manuals provide more detail on the safety requirements.

Essential Equipment for Your Protection - general guidance only



Head, eye and hearing protection

Helmet to EN397 or high performance EN14052:2012+A1:2012

Eye protection to EN166 - B - safety glasses.

EN166 - A - visors or mesh type EN1731:2006 Spec A

Hearing protection to EN352-1: 2002

Dust masks are essential for use with grinding wheels



Hand protection

Gloves to EN12477:2001 - sturdy welding quality

Gloves to EN381-7 - for chainsaw use



Foot protection

Boots to EN20345:2011 - general workboots

Boots to EN17249 or EN381-3 - chainsaw use



Leg protection

Sturdy full length trousers to EN381-5 for chainsaw use

Specifications correct at time of printing, please see the latest HSE for more guidance. Portek cannot be held liable for any injuries or damages that may occur, if instructions are not read and understood and/or personal safety equipment is not worn as described in the equipment Operator's Manual

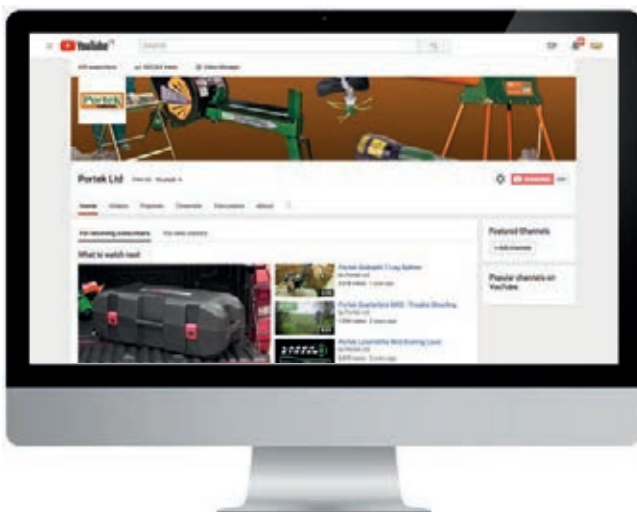

See our products in action on our
Youtube Channel:
[youtube.com/user/PortekMedia](https://www.youtube.com/user/PortekMedia)

Latest news, products and events
on Facebook:
[facebook.com/portekltd/](https://www.facebook.com/portekltd/)



portek.co.uk

2019



Portek Ltd.
Bryn Hall, Knolton Bryn
Overton-on-Dee
Wrexham, LL13 0LF
Tel: 01234 889 454
Fax: 01234 889 464

Sales enquiries

Email: sales@portek.co.uk

General enquiries

Email: info@portek.co.uk

Remittance and accounts enquiries

Email: accounts@portek.co.uk